

PLAN VIEW

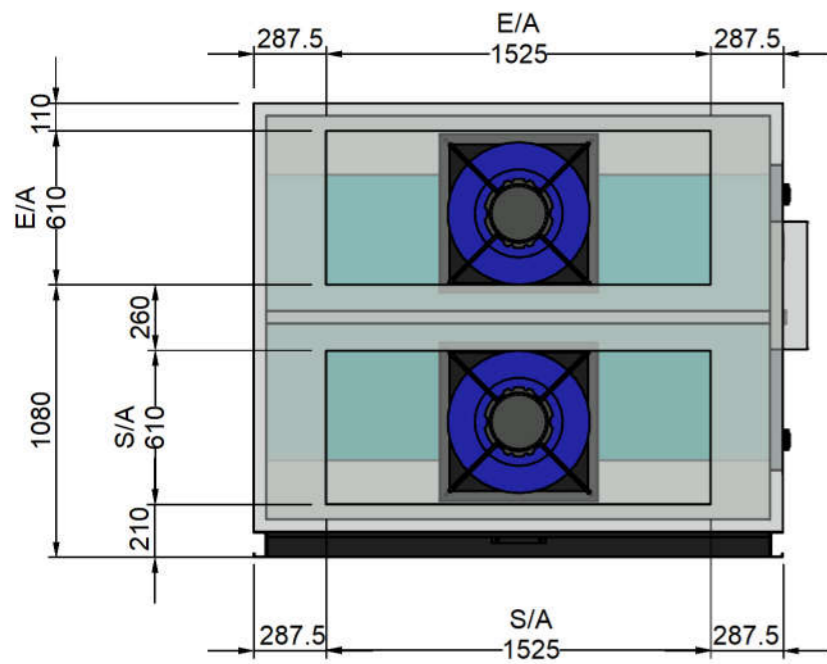

E/A & S/A SPIGOTS

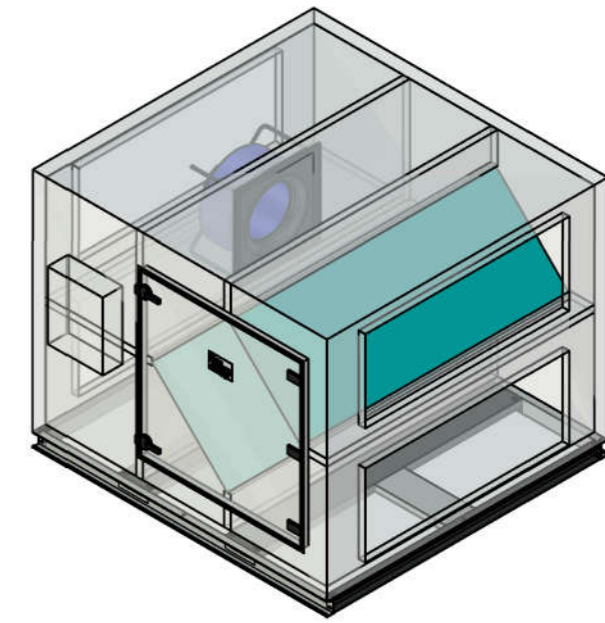
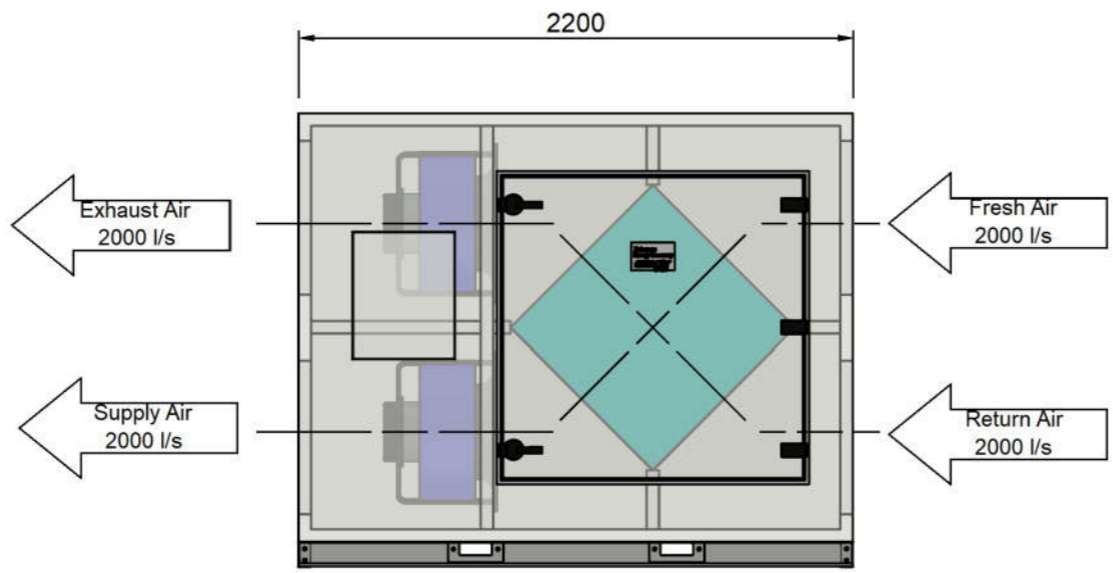

ELEVATION VIEW - ACCESS PANEL SIDE

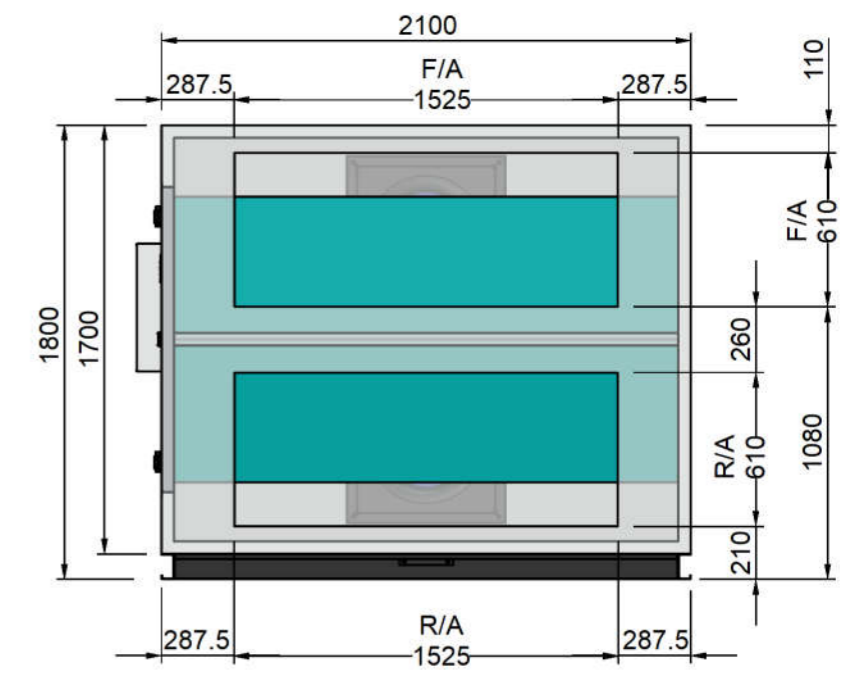

F/A & R/A SPIGOTS

ENG NOTES:

- All Panels are 50mm Colorbond Panel Casing
- Minimum 1200mm Clearance Required from Access Panel

	Scale	General Tolerances acc to : ISO 2768-1 medium	Project.	STANDARD DRAWING		
	Armcor Air Solutions 109-111 Northcorp Blvd Broadmeadows VIC 3047 Phone 03 8301 9200 Web: www.armcor.com.au Email: sales@armcor.com.au		Drawn. P.Z Title. EXTERNAL UNIT ERV Model. XEM2000P3	Status. In Process Date. 7/05/2018 1:39 PM	Sheet 1 of 2 Rev. A	SN.