

© Copyright: No part of this drawing or design shall be reproduced without authority or consent from Company. All references herein are deemed confidential

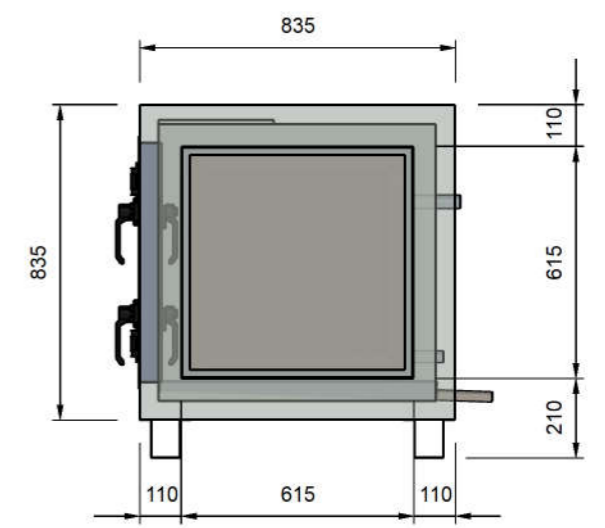
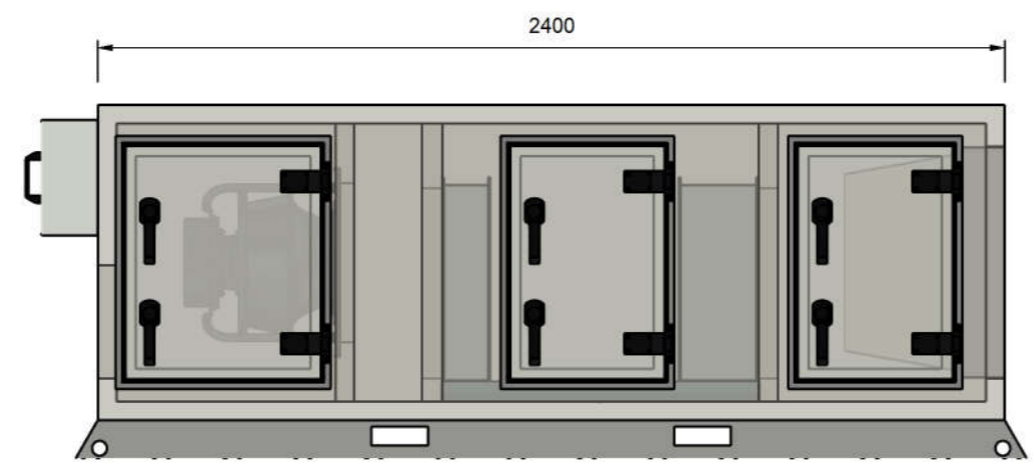
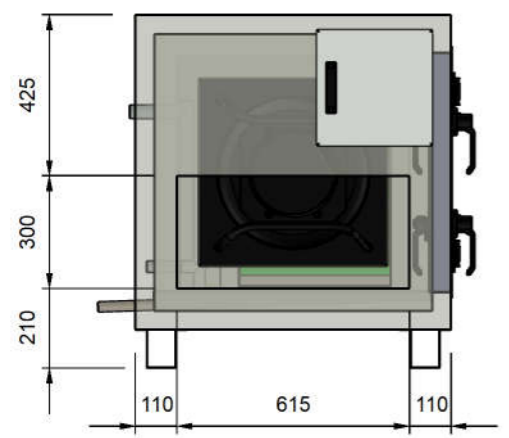
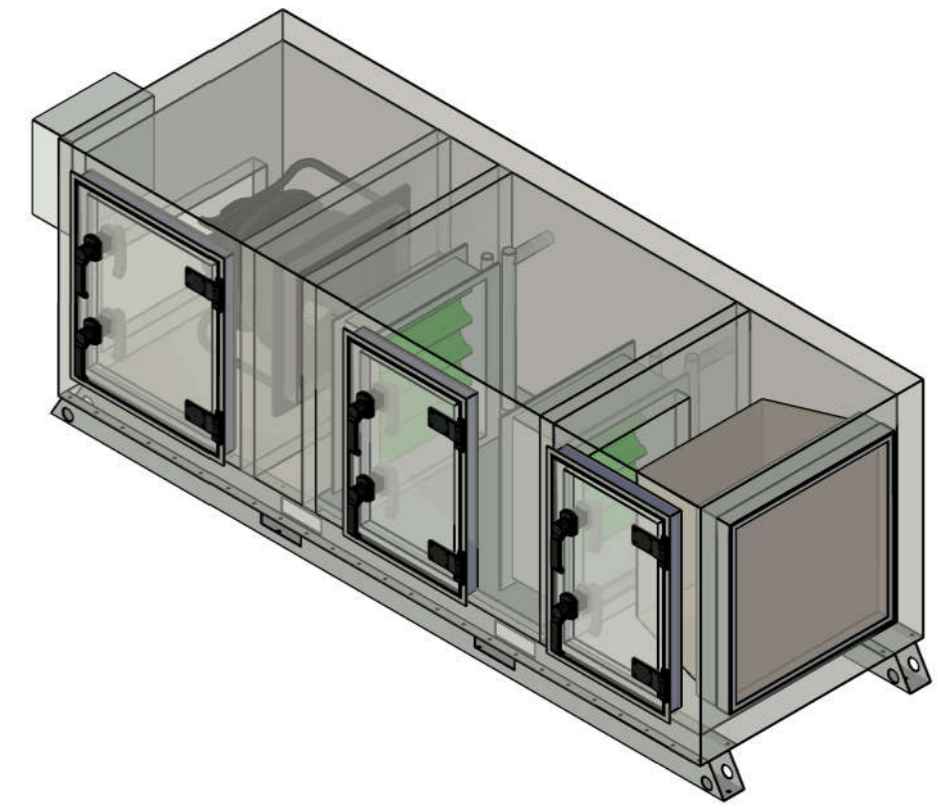
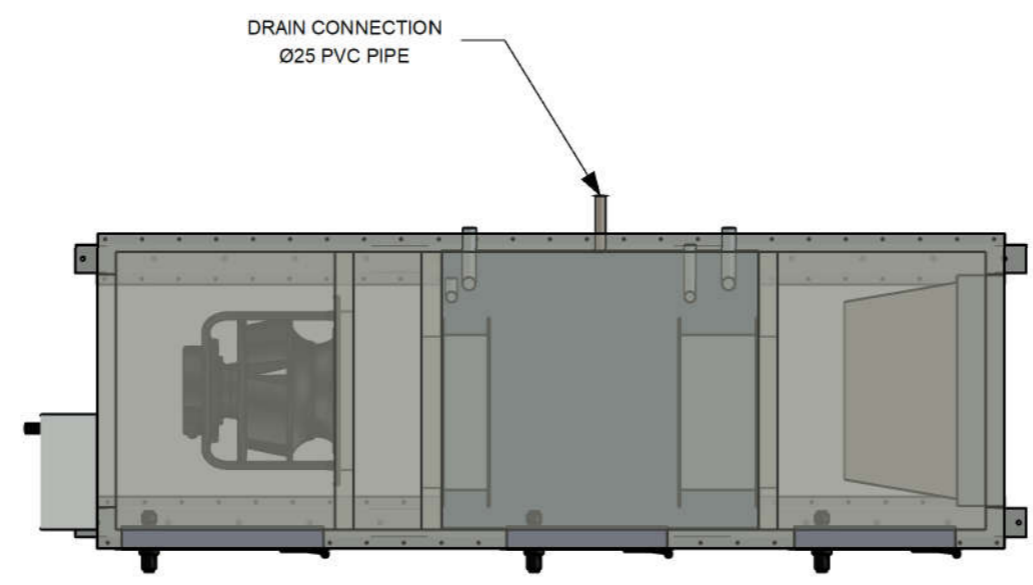

Notes:
 - All Panels are 50mm Colorbond Panel Casing
 - Minimum 1200mm Clearance Required from Access Panel

If this drawing meets your requirement in both design and performance please sign and email to Armcor Air Solutions

Approved _____

Date _____

E	A3	General Tolerances acc to : ISO 2768-1 medium	STANDARD DRAWING		
	Scale		Drawn NT	Checked	Dat. 11/04/2023 8:51 AM
		Title AHU500P3	Sheet 1 of 2	Rev. A	
			S/N.		