

Nutserts Provided in Body for Bolts

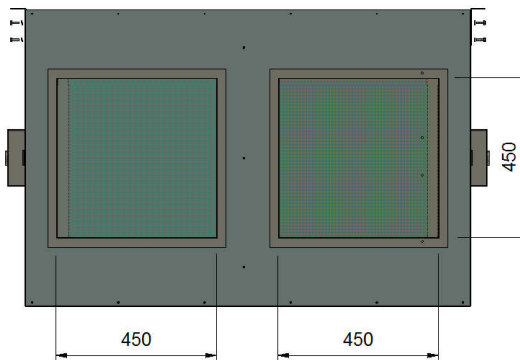
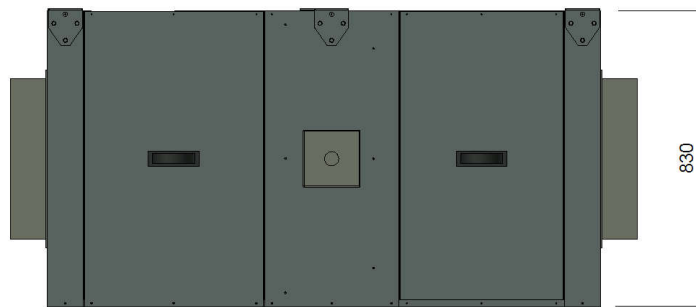
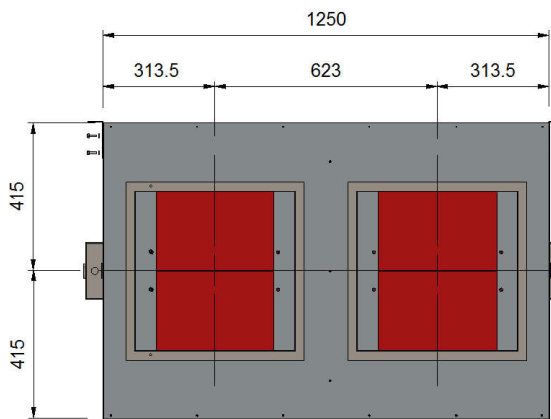

Item	Description	Qty
1	AFMC Blower 10x10 750W	4
2	EC FAN K3G 355AY4002	1
3	Electrical Inlet	2
4	Fan Access Panel	2
5	Filter Access Panel	2
6	Heat Exchange Media 800x800	1
7	Panel Prefilter 800x690x50mm	2

	Scale	General Tolerances acc to:		Project: <b>STANDARD DRAWING</b>	
	A3	ISO 2768-1 medium		Drawn. P.Z	Status.
	Armcor Air Solutions 109-111 Northcorp Blvd Broadmeadows VIC 3047 Phone 03 8301 9200 Web: www.armcor.com.au Email: sales@armcor.com.au				Date. 2/11/2016 10:49 AM
	Title: <b>EXCHANGE ERV - CEILING MOUNT</b>			Rev. A	
Model: <b>Model XCM1200C1</b>				SN.	